

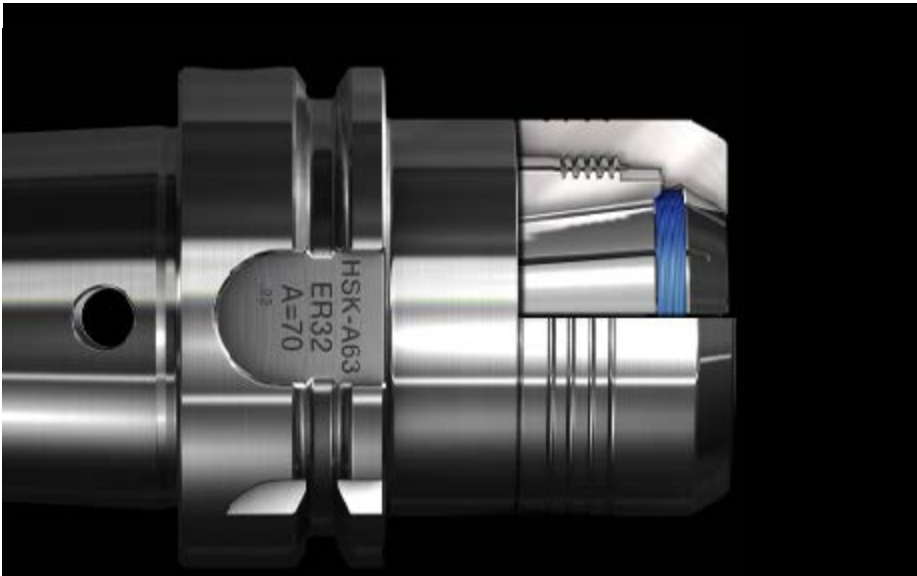

## Operating instructions

Precision Collet Chuck  
CENTRO|P



## Foreword

These operating instructions will help you to use the precision collet chucks CENTRO|P, which are suitable for the universal and high-precision use, both

- as intended
- and safe.

Before using them, please read the operating instructions and keep them at hand for the operating personnel.

If you do not understand individual pieces of information in these operating instructions or if there is a lack of information, ask your responsible contact person.

## Table of contents

Page

Important hints	3
General hints	3
Mounting	4
Assembly	4
Clamping / releasing	5
Clamping torques	6
Technical indication	7
Safety	8
Care and storage	9
Source of errors	10

## Important hints

- i** Only clamp tool shanks with nominal diameter of the collet and shank tolerance up to h10 in the CENTRO|P!
- i** Before clamping, the CENTRO|P tool holder, collet, clamping nut as well as the tool shank must be cleaned properly (follow care instruction point 5). Impurities affect the clamping force, precision and service life of the clamping system.
- i** The shank of the cutting tool must be clamped over 3/4 of the clamping bore length at least (completely in case of small  $\emptyset$ ). Otherwise, concentricity problems or a loss of holding force may occur.

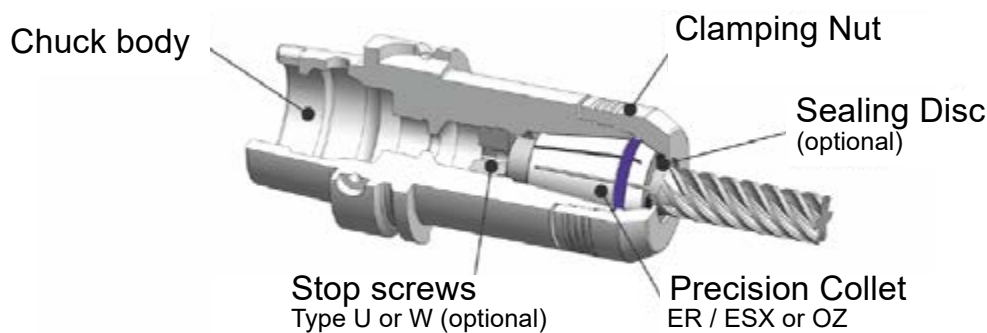

## General hints

- i** **System accuracy**  
 In order to guarantee the system accuracy of  $3\mu\text{m}$ , original FAHRION Precision Collets DIN ISO 15488 (ER/ESX) GER-HP /-HPD/-HPDD or DIN ISO 10897 (OZ) form B must be used, since they are perfectly matched to the chuck.
- i** **Clamping nuts**  
 The clamping nuts are available in two versions:
  - Version HPC without seal
  - Version HPC-DI with seal – for inner coolant supply as well as to avoid ingress of dirt and swarf into the chuck.
- i** **Collets**  
 The CENTRO|P is available in two versions for different collets:
  - CENTRO|P GER – for precision collets DIN ISO 15488 (ER/ESX) GER-HP (standard) / GER-HPD (with sealing for internal cooling) / GER-HPDD (with sealing for internal cooling and spray nozzles) as well as tapping collets with internal square drive similar to DIN ISO 15488 GER-GBD (with sealing for internal cooling) / GER-GBDD (with sealing for internal cooling and spray nozzles). Tapping collets by competitors may only be used in the tapping chuck SYNCHRO|T with minimum length compensation.
  - All collets for the CENTRO|P GER are supplied with the FAHRION|Protect coating which provides a long-term protection against corrosion.
  - CENTRO|P GOZ – for precision collets DIN ISO 10897 (OZ) form B.



## Mounting



Before installing the components, they must be inspected and cleaned (follow care instruction point 5), especially when replacing individual components. In order to ensure the high concentricity, attention must be paid to highest cleanliness.

Damaged and/or worn parts must be replaced.

Only clamp tool shanks with nominal diameter of the collet and shank tolerance up to h10!

## Assembly

1. If necessary, insert the seal (the vulcanised side must locate against the collet face).
2. Press the collet axially into the clamping nut until the collet head clips into the extraction groove (note: no eccentric).
3. Position the cutting tool into the collet



Before assembling the collet with the collet holder, the collet must be inserted into the clamping nut.

4. Screw on the clamping nut by hand loose on the chuck body.
5. Insert the cutting tool to the correct length or until it reaches the stop.



Fig. 1

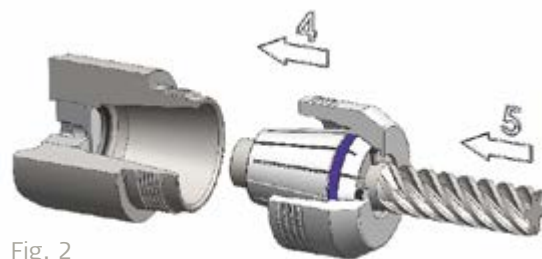

Fig. 2



In the case of short chucks, make sure that the cutting tool does not contact the chuck at the rear, as otherwise the concentricity will be impaired.



When loosening the clamping nut the collet is extracted out of the chuck body. Having removed the cutting tool from the collet, lateral pressure to the collet will aid removal from the clamping nut.

## Clamping / releasing

**i** We recommend the use of a torque wrench with the corresponding roller bearing head for clamping to achieve the optimum clamping force, particularly for milling.  
 Do not overtighten the recommended torques!  
 A roller wrench with a handle should be used to open the clamping nut. It is not recommended to open the clamping nut with a torque wrench.

**i** In order to ensure an immediate hold of the roller bearing wrench, the roller cage must be twisted against the pulling direction



**1. Attaching**



**2. Twisting of the cage**



**3. Tightening**

**i** The maximum torques can be read below and on the clamping nuts. Please note, however, the smaller the diameter to be clamped, the smaller the clamping torque required.

**i** For heavy roughing, we recommend tensioning the clamping nut 5-fold to achieve the optimal holding force.

**i** In the case of finishing operations we recommend tightening the clamping nut to 50-70% of the maximum tightening torque in order to achieve the optimum machining results by means of higher cushioning; otherwise, the following maximum tightening torques – referenced to the diameter to be clamped – can be used.

# Clamping torques (Ma)

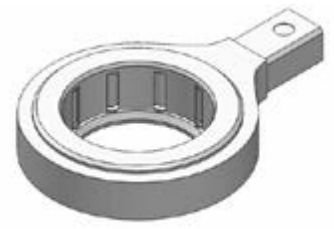
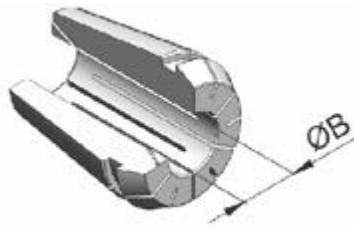

CENTRO P		Collets GERC		Wrenches		
Chuck type	D	Fitting Collets	B mm	Max. Ma	Wrenches	Heads for Torque setting wrenches
CP8M	Ø10	GERC8-B/-HP	1,0-2,5 * + 1/16" * 3,0-5,0 + 1/8"•3/16"	5 8	ROD10	-
CP11M	Ø16	GERC11-B/-BD/ -HP/-HPD	1,0-2,5 * + 1/16"•3/32" * 3,0-7,0 + 1/8"•5/32"•3/16"•7/32"•1/4"	7 10	RO16	DRO16 (9x12 mm)
CP16M	Ø22		1,0 * 1,5-3,5 * + 1/16"•3/32"•1/8" * 4,0-4,5 * + 5/32"•3/16" * 5,0-10,0 + 7/32"•1/4"•9/32"•5/16"•11/32"•3/8"	10 15-20 25-30	RO22	DRO22 (9x12 mm)
CPC16	Ø24	GERC16-B/-BD/ -HP/-HPD/-HPDD/ -GBD/-GBDD	1,0 * 1,5-3,5 * + 1/16"•3/32"•1/8" * 4,0-4,5 * + 5/32"•3/16" * 5,0-10,0 + 7/32"•1/4"•9/32"•5/16"•11/32"•3/8"	10 25-30 50-55	RO24	DRO24 (9x12 mm)
CP16	Ø30		1,0 * 1,5-3,5 * + 1/16"•3/32"•1/8" * 4,0-4,5 * + 5/32"•3/16" * 5,0-10,0 + 7/32"•1/4"•9/32"•5/16"•11/32"•3/8"	10 25-30 50-55	RO30	DRO30 (14x18 mm) **
CP20	Ø32	GERC20-B/-BD/ -HP/-HPD/-HPDD/ -GBD/-GBDD	1,0-3,0 * 3,0-5,5 * + 1/8"•3/16" * 6,0-9,0 + 1/4"•5/16" 9,5-13,0 + 3/8"•7/16"•1/2"	15-20 30-35 50-55 70-75	RO32	DRO32 (14x18 mm) **
CP25	Ø40	GERC25-B/-BD/ -HP/-HPD/-HPDD/ -GBD/-GBDD	1,0-3,0 * 3,5-6,5 * + 1/8"•3/16"•1/4" * 7,0-10,0 + 5/16"•3/8" 10,5-16,0 + 7/16"•1/2"•9/16"•5/8"	25-30 35-40 55-60 80-90	RO40	DRO40 (14x18 mm)
CP32	Ø50	GERC32-B/-BD/ -HP/-HPD/-HPDD/ -GBD/-GBDD	2,0-3,0 * 3,5-6,5 * + 1/8"•3/16"•1/4" * 7,0-15,5 + 5/16"•3/8"•7/16"•1/2"•9/16" 16,0-20,0 + 5/8"•11/16"•3/4"	30-35 55-60 110-120 130-140	RO50	DRO50 (14x18 mm)
CP40	Ø63	GERC40-B/-BD/ -HP/-HPD/-HPDD/ -GBD/-GBDD	3,0-7,5 * + 1/8"•3/16"•1/4" * 8,0-11,5 + 5/16"•3/8"•7/16" 12,0-17,5 + 1/2"•9/16"•5/8"•11/16" 18,0-26,0 + 3/4"•13/16"•7/8"•1"	60-70 100-110 140-150 190-200	RO63	DRO63 (14x18 mm)

\* Ø with a short bore. The remaining Ø have a through bore.

\*\* old version DRO30/32 (9 x 12 mm)

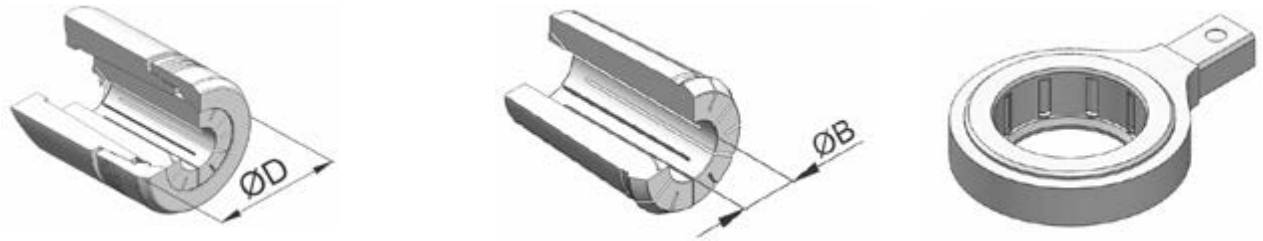

CENTRO P		Collet GOZ		Wrenches		
Chuck type	D	Fitting Collets	B mm	Max. Ma	Wrenches	Heads for Torque setting wrenches
CP225DG	Ø50	FM25DG FM25CDG-HP	2,0-3,5 *	30-35	RO50	DRO50 (14x18 mm)
			4,0-6,5 * + 1/4" *	55-60		
			7,0-7,5•8,5 *	110-120		
			8,0•9,0-15,5 + 3/8"•1/2"	130-140		
CP432DG	Ø63	FM32DG	4,0-7,5 *	100-120	RO63	DRO63 (14x18 mm)
			8,0-11,5 *	140-150		
			12,0-19,5	170-180		
			20,0-32,0	250-260		

\* Ø with a short bore. The remaining Ø have a through bore.

## Technical indication



### Tool length pre-setting

Tool length pre-setting is possible from the front as well as from the rear through the chuck body using an optionally available adjustable stop screw.



### Adjustable stop screw

In order to clamp the cutting tool in the optimum position (i.e. as short as possible, but as long as necessary), we offer two types of adjustable stop screws as options:

1. type U, for long tool shanks that go through the collet into the collet chuck and
2. type W, when the tool shank ends in the collet.



### Coolant supply

CENTRO|P with adaptor DIN69871 and CAT are supplied in form AD or AD/ B. In the case of AD/B the delivery condition is form AD (centrally through the pull stud).

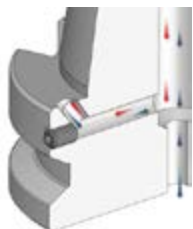

Fig. 3

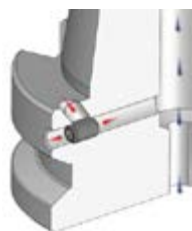

Fig. 4

If form B (coolant supply through the collar) is required, the two grub screws at the Vee flange must be screwed out, however, they must still remain in the chuck body. (figure 1 and 2)

In some AD/B versions the grub screws have to be screwed out completely for form B.



### Balancing

Most CENTRO|P chucks are balanced as standard to G2.5 at 25,000 rpm or  $U \leq 1$  gmm. For higher demands in the case of long and thin chucks (dynamic balancing only necessary if  $n > 20,000$  rpm and dimension  $A > 2 \times D$  outer diameter of the adaptor) we recommend our system Balance, which can be rebalanced in two levels.

# Safety

In order to ensure the reliable use, the following instructions and technical data must be observed!

## During the assembly



The tools may have sharp cutting edges and can cause cuts.  
Wear protective gloves for tool change!  
When used under rotation, protective covers according to EC Machinery Directive must be considered.



Only use pull studs and holders that are suitable for the machine spindle.

## During machining



Observe the recommended cutting speeds of the tool manufacturers.



Be aware of the safety instructions of the machine or other tools used! Never work with open machine door, especially at high speed or when using HSK tapers. Collisions at high speed could result in breakage of the cutting tool or collet chuck causing serious injury. The maximum speed must never be exceeded.



Do not continue machining if vibrations or chattering can be noticed.



Never touch the chuck or the cutting tool while the spindle is running.



In cases where the balancing quality is relevant to safety or is prescribed by the machine manufacturer, the complete clamping system including the cutting tool must be checked for unbalance and rebalanced if necessary.

## General notes



### Intended use

CENTRO|P is a precision tool and must be handled carefully accordingly. Avoid mechanical, chemical or thermal influences beyond the loads of the intended use.





Clamping tools and inserting the collet into the clamping chuck may only be performed by technically trained personnel. In this connection, the technical data of the clamping chuck must be observed.



## Care and storage

 Store CENTROIP and its components in a cleaned and slightly oil condition. The factory-provided lubricant/preservation film must not be removed on the inside of the clamping nut. In order to maintain the nut, we recommend to rub it using a soft cloth without solvent-containing cleaning agents.

 As a rule, in the event of strong scaling, the chuck bodies and collets can also be cleaned in solvents. If the clamping nut is cleaned in solvents, the trapezoid thread must subsequently be treated with suitable lubricant. We recommend Hölterol LW 1362.

 When cleaning, avoid permanent contact with aggressive and solvent-containing chemicals/ cleaning agents. Solvents are, for example, contained in: Benzine, thinner, brake cleaner etc.

## Source of errors

Fault	Cause	Elimination
unacceptable tool runout	dirt/swarf in chuck body, clamping sleeve, clamping nut or at the tool shank	clean all parts intensively and care for absolute cleanness
	cutting tool itself inaccurate, for example long drills	check cutting tool accuracy
	tool shank is not clamped sufficiently, minimum 3/4 (at small Ø completely) of the clamping length of the collet	tool shank to be inserted the whole length of the collet
	tool shank contacts the chuck (possible especially with short chucks)	pull the cutting tool out a little
	a worn, damaged or third party collet is in use	always use new original FAHRION precision collets
	bearing in the pre-setter or in the accuracy check machine is not o.k.	Contact the service of the respective device
Milling cutter is pulled out	HPC clamping nut was degreased	Oil using universal oil (e.g. WD40 or equivalent)
	Clamping nut tightened too weakly or too slowly	Dynamically tighten clamping nut with nominal torque
	No more Teflon coating on the HD clamping nut	Re-treat using Teflon spray (e.g. Ballistol Klever PTFE Teflon or equivalent)
unacceptable tool runout after automatic tool change	bearing problem in the machine	check the concentricity in the collet closing taper (without collet)
	internal cone of the machine is worn or there is dirt/swarf	
	automatic tool changer is not aligned to the machine spindle	clamp chuck by hand to check
coolant is escaping through the clamping nut	wrong seal is inserted – shank-Ø is smaller than the Ø to be sealed	replace seal for correct size
	aggressive coolant	replace seal for new one
	tool is inserted with the cutting edge through the seal	replace seal if damaged and re-position tool
no coolant comes through the tool	coolant bores in the chuck, stop screw or the coolant supply of the machine are impaired.	clean the coolant bores with a cleaning medium (not acidic, because of the rust)



FAHRION offers a wide selection of precision collets, precision collet chucks as well as precision products for workpiece clamping which fulfil maximum requirements in terms of concentricity, service life and manufacturing quality. In doing so, FAHRION pays particular attention to user-friendly technology oriented towards the practical requirements of the users, which is constantly advanced.

The latest catalogue information is available  
at any times at [www.fahrion.de](http://www.fahrion.de)

Eugen Fahrion GmbH & Co. KG  
Forststraße 54  
73667 Kaisersbach  
Germany  
Phone +49 7184 9282-0  
[sales@fahrion.de](mailto:sales@fahrion.de)  
[www.fahrion.de](http://www.fahrion.de)